

YU600

Oxygen Concentrator

User's Manual



Please read the user's manual closely before using!

TABLE OF CONTENTS

SAFETY NOTES-----	1-2
FEATURES-----	3-4
OPERATING & INSTALLATION-----	5-9
MAINTENANCE-----	10-12
OTHER ATTENTION ITEMS-----	13-14

WARNING: For avoiding power outage or oxygen concentrator operating failure, exigent oxygen user and serious patient must equip with reserve oxygen supply (for example: oxygen cylinder, oxygen bag). This device must equip with reserved oxygen supply and is not used as life supporting or life sustaining.

BEFORE INSTALLATION

- The concentrator should always be kept in the upright to prevent cabinet damage when transporting.
- When the electrical source, power voltage is beyond the normal power voltage range. Please add voltage stabilizer.
- Use eligible, safe power set and junction box.
- Only the technician can open the oxygen concentrator's cabinet.

STRORGE PLACE

- Keep the concentrator away from inflammable and explosive occasions.
- The concentrator should be placed in a ventilated room without direct sunlight. Place the unit away from all sides for at least 10cm (4inches) from walls, draperies, furniture, or other obstruction. Do not place the unit in a confined area.

SAFETY NOTES

- Oxygen concentrator must avoid from heat, fire, moisture, exorbitant or over-low extrem condition.
- Sundries and vessel should not be placed on top of the concentrator.
- NEVER put any stuff under the machine to prevent blocking the air inlet or outlet of the unit. Otherwise may cause high temperature to shut down the machine or low oxygen concentration.

USING

- Oxygen is combustion-supporting gas. Users MUST NOT SMOKE while using this device. Keep all matches, lighted cigarettes or other sources of ignition out of the room in which this product is located.
- A spontaneous and violent ignition may occur if oil, grease or greasy substances come in contact with oxygen under pressure. These substances MUST be kept away from the oxygen concentrator.
- Do not place the machine in a damp room or near other liquid.

FEATURES

SUMMARY

The function of oxygen

- Oxygen could improve body function, especially suit for elderly, pregnant women, physique, students etc. Who got physiological hypoxia. It may also reduce fatigue after heavy manual or mental consumption.

THE SCOPE OF PRODUCTS

Produce oxygen for personal homecare and cosmetics.

STRUCTURE

- Safety plastic shell.
- With infrared remote control system, can be operated conveniently.
- With time collect function: Display the operation time in LCD.
- With timing power off function.
- Anion generating function can improve the alveolar ventilation function and increase the oxygen absorption rate.
- The compressor with thermal protector guarantee better security.

SPECIFICATIONS

1. Power Supply:

AC100V ± 10% AC120V ± 10% AC220V ± 10% AC230V ± 10%
50Hz 60Hz

2. Input Power: 150VA

3. Oxygen Concentration: 70%~90%

FEATURES

4. Flow Range: 1 ~ 3L/min

5. Noise: $\leq 45\text{dB(A)}$

6. Weight: 8kg

7. Dimension: W37.7cm (14.8") x D19cm (7.5") x H31.7cm (12.5")

8. Safety system:

Current overload or loose connection, automatic shutdown;

Compressor with abnormal high temperature, automatic shutdown;

9. Electric classification: Class II

10. Work system: work continuously.

11. NORMAL OPERATION CONDITIONS:

Temperature range: $10^{\circ}\text{C} \sim 40^{\circ}\text{C}$ ($50^{\circ}\text{F} \sim 104^{\circ}\text{F}$);

Relative humidity: 30% ~ 75%;

Atmosphere pressure: 860hPa ~ 1060hPa(12.47psi ~ 15.37psi);

NOTE: When storage temperature is below 5°C , please keep the equipment in normal working condition for at least 4 hours before using.

12. Transportation and storage conditions:

Temperature range: $-20^{\circ}\text{C} \sim +60^{\circ}\text{C}$ ($-4^{\circ}\text{F} \sim +140^{\circ}\text{F}$),

Relative humidity: 10% ~ 93%, no condensation,

Atmosphere pressure: 700hPa ~ 1060hPa(10.15psi ~ 15.37psi).

NOTE: Oxygen concentrator should be stored with out intense sunlight, no corrosive gas and in a well ventilated room, avoid jolt and inverted recumbent transport.

OPERATING & INSTALLATION

UNPACKING

- ▶ Check for any obvious damage to the carton or its contents before using. If damage is evident, please notify the carrier or local dealer.

FEATURE VIEW

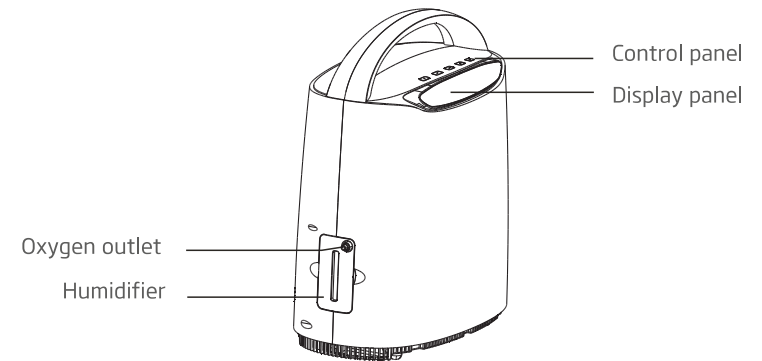

Figure 1: Front view of the machine

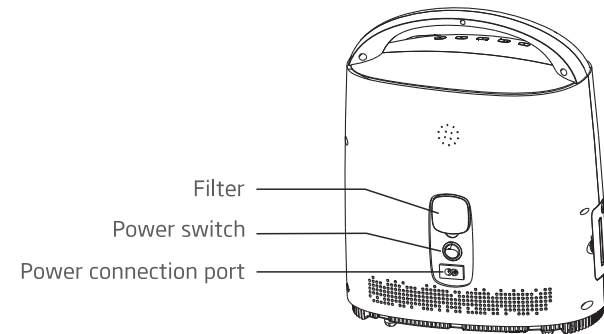

Figure 2: Back view of the machine

OPERATING & INSTALLATION

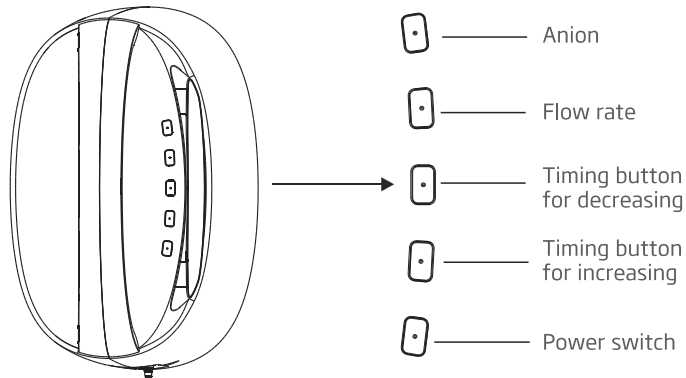

Figure 3: View of the control panel

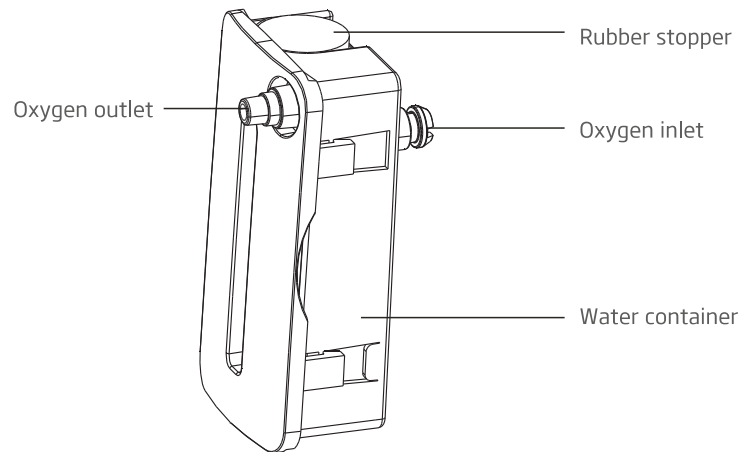

Figure 4: View of the humidifier

OPERATING & INSTALLATION

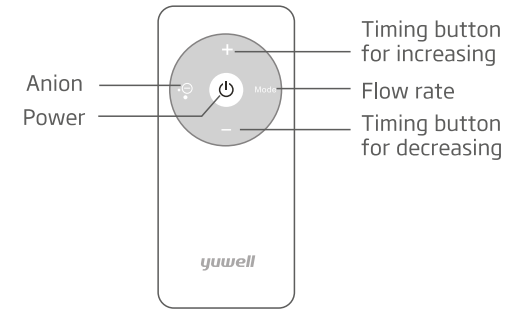

Figure 5: View of the telecontroller

PREPARE WORK

- ▶ Pull out the humidifier as the direction in Figure 6, remove the rubber stopper, then fill the bottle with pure water (or distilled water) to the level indicated by the manufacturer.(Figure 6)
- ▶ Note: The machine can generate oxygen also without water in the water container.
- ▶ Connecting the power source: connect the power cord to the power connection port of the machine.
- ▶ Turn the power switch to " | ", the LCD showing "HELLO" indicates that the machine is normal. 4 seconds later, the LCD shows flow rate, oxygen concentration, elapsed time, then the machine goes to normal operation.

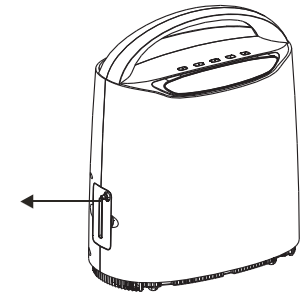

Figure 6

OPERATING & INSTALLATION

PERFORM THE OXYGEN INHALATION

- ▶ Push the "FLOW RATE" button on the control panel to require oxygen need, the display screen shows the flow rate and oxygen concentration. Meanwhile oxygen comes from the oxygen outlet.
- ▶ Connect the nasal oxygen cannula to the oxygen outlet of the humidifier, the other end match the patient.

TIME SETTING

This machine has timer function, users can set in the range of 10 minutes ~ 2 hours.

- ▶ When LCD shows "--" it means continuous operation state.
- ▶ Every time press the "+", means runtime increases 10 minute, press for more than 1.5 seconds for continuous increasing."
- ▶ Every time press the "-", means runtime decreases 10 minute, press for more than 1.5 seconds for continuous decreasing.
- ▶ The oxygen concentrator will automatically shut down meanwhile LCD shows "0" when time runs out.

ANION FUCTION

- ▶ Press the "ANION" button on the control panel to generating anion of oxygen.

TURNNING OFF

- ▶ Push the power switch on the control panel to suspend inhaling oxygen.

OPERATING & INSTALLATION











- ▶ Take off nasal oxygen cannula from oxygen outlet first, close power switch, and then cut off power source.

INFRARED REMOTE CONTROL SYSTEM

- ▶ Remote operating the machine with the telecontroller, it's function is as same as the control panel of the machine.

Note: The telecontroller should be aimed at the remote receiving device while using.

SYMBOLS

Symbol	Description	Symbol	Description
	Alternating current		Consult the manual
	Class II Equipment		OFF(power, disconnection from the mains)
	ON(power, connection to the mains)		KEEP DRY
	KEEP UP		TEMPERATURE LIMIT
	FRAGILE		NO SMOKING

MAINTENANCE

- ⚠ WARNING: CUT OFF the power supply first. To avoid electrical shock, DO NOT remove cabinet.

CLEANING CABINET

Clean the cabinet with a mild household cleaner and non-abrasive cloth or sponge at least one time each month.

CLEANING OR REPLACING FILTERS

Please clean and replace the filters in time, it's very important to protect compressor and delay machine's life.

- ⚠ CAUTION: DO NOT operate the concentrator without the filters installed.

- ▶ The mesh in filter cleans once half a month. (See Figure 7, Figure 8) Filter can be taken out from the back panel.

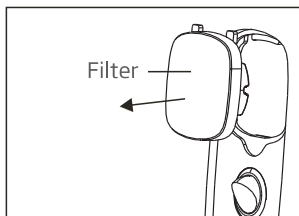

Figure 7

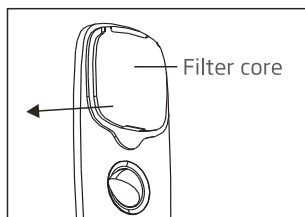

Figure 8

- ▶ The frequency for replacing the filter mesh depends on practically using and condition. If the filter core turns black, please replace it at once, no matter how long it used.
- ▶ Clean the filters with a vacuum cleaner or wash in warm soapy water and rinse thoroughly. DRY the filters thoroughly before reinstallation.

MAINTENANCE

CLEANING THE WATER CONTAINER

- ▶ Change the water in the humidifier everyday.
- ▶ Clean the water container and the rubber stopper once a week to ensure generating clean oxygen.

Note: If the water container smells not good, soak it in white vinegar for half an hour then rinse thoroughly with water.

- ▶ Disassemble the humidifier
 - (1) Pull out the humidifier as the direction in Figure 9.
 - (2) Remove the rubber stopper (Figure 10).

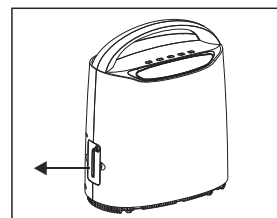

Figure 9

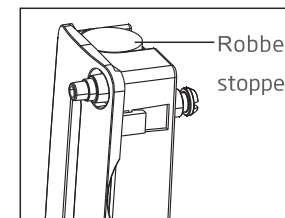

Figure 10

CHANGING THE NASAL OXYGEN CANNULA

- ▶ Clean it once every three days. Clean the head of it every time: soak it in white vinegar for 5 minutes then rinse thoroughly with water or rub with medical alcohol. Change the oxygen pipe every two month. (Please keep the oxygen pipe dry)

MAINTENANCE

TROUBLE SHOOTING GUIDE

Symptom	Probable reasons	Solution
The machine doesn't work and the display screen shows nothing while the power supply has been linked	1)The power is no sufficient at outlet	1)Do not use extended cord
	2)Contact dealer or manufacturer if the machine still doesn't work	
Concentrator is working, but oxygen from outlet is little or no	1)The nasal cannula kinked or blocked	1)Replace it
	2)Humidifier leaked	2)Reinstall and tighten it
	3)Water container blocked	3)Clean the water container
	4)Filter core get dirty	4)Clean or replace the filter
	5)Contact dealer or manufacturer if the problem still can not be solved	
The machine doesn't work and the display screen shows "FAULT" while the power supply has been linked	1)Compressor with abnormal high temperature, automatic shutdown	2)Cut off the power and cool the machine
	2)If this state continues, stop using the concentrator and get in touch with the supplier at once	

△Contact dealer or manufacturer if the problem still can not be solved.

OTHER ATTENTION ITEMS

GAS PASS OPERATION SKETCH MAP:

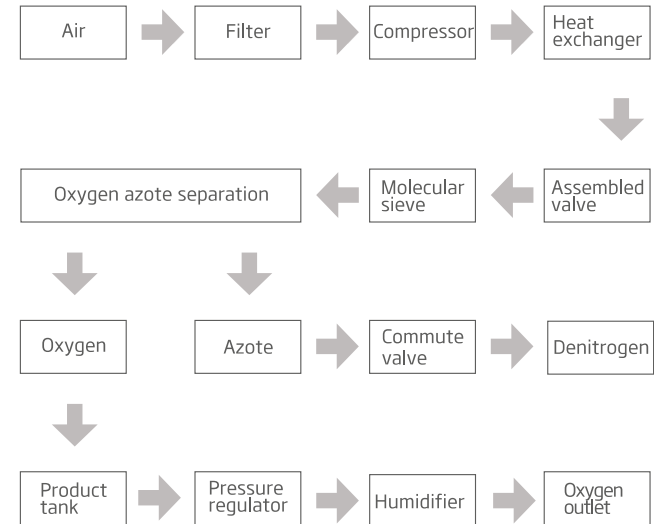

RADIO FREQUENCY INTERFERENCE

To avoid influencing by Radio Frequency Interference (RFI). CAUTION should be exercised with regard to the use of portable communications equipment in the area around such equipment.

Do not disassemble the machine personally. Any professional maintenance personnel need the electrical rationale digram, please contact dealer or manufacturer.

OTHER ATTENTION ITEMS

ACCESSORIES LIST

1. Oxygen concentrator	1 set
2. User's manual	1 piece
3. Nasal oxygen cannula	1 set
4. Headset type oxygen uptake	1 set
5. Filter core	1 set
6. Warranty card	1 piece
7. Power cord	1 set

All specifications and product configurations are subject to change without notification.