

yuwell

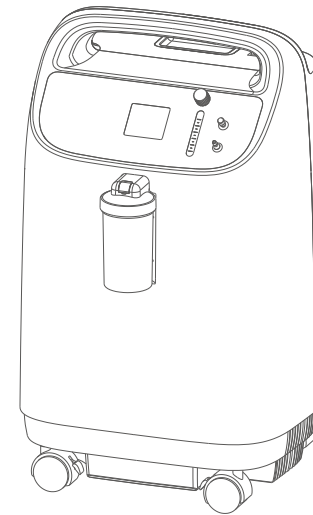

8F-10/8F-10W
/8F-10(Dual Flow)
Oxygen Concentrator

User's Manual



SAFETY NOTES

Table Of Contents

Safety Notes-----	1-4
Features-----	5-8
Handling-----	9-9
Operating & Installation-----	10-17
Maintenance-----	18-20
Trouble Shooting Guide -----	21-23
Other Attention Items-----	24-25

WARNING: For avoiding power outage or oxygen concentrator operating failure, exigent oxygen user and serious patient must equip with reserve oxygen supply (for example: oxygen cylinder, oxygen bag). This device is to be used as an oxygen supplement and is not considered for life supporting or life sustaining.

I . Before Installation

- The concentrator should always be kept in the upright to prevent cabinet damage when transporting.
- When the electrical source power voltage is beyond the normal range. Please add voltage stabilizer.
- Use eligible, safe power set and junction box.
- Only the qualified technician can open the oxygen concentrator's cabinet.

II . STORAGE PLACE

- You may select the most suitable room when using your oxygen concentrator. Use the casters to transfer the concentrator from room to room.
- Place the unit away from all sides for at least 10cm (4inches) from walls, draperies, furniture, or other obstruction. DO NOT place the unit in a confined area.
- Oxygen concentrator must avoid from heat, fire, moisture, exorbitant or over-low extreme condition.
- Sundries and vessel should not be placed on top of the concentrator.
- NEVER block the air inlet of the unit or place it on a soft surface, such as a bed or couch, where the air inlet may be blocked. Keep the inlet free from lint, hair, etc.

SAFETY NOTES

III. USING

- The use of oxygen therapy requires that special attention to reduce the risk of fire. Users **MUST NOT SMOKE** while using this device. Keep all matches, lighted cigarettes or other sources of ignition out of the room in which this product is located. **NO SMOKING** signs should be prominently displayed. Textiles and other materials that normally would not burn are easily ignited and burn with great intensity in oxygen enriched air. Failure to observe this warning can result in severe fire, property damage and cause physical injury or **DEATH**.
- For optimum performance, do not open or turn off the concentrator frequently, reset after 3~5 minutes. Shorter periods of operation may reduce maximum product life.
- A spontaneous and violent ignition may occur if oil, grease or greasy substances come in contact with oxygen under pressure. These substances **MUST** be kept away from the oxygen concentrator, tubing and connections, and all other oxygen equipment. **DO NOT** use any lubricants unless recommended by manufacturer.

IV. MAINTENANCE

Only the authorized or trained technician can perform the maintenance or adjustments to the oxygen concentrator. The manufacturer recommends each operation time should not be less than 30 minutes, do not frequently press the switch in order to extend the operation life to the machine.

V. RADIO FREQUENCY INTERFERENCE

Most electronic equipment is influenced by Radio Frequency Interference (RFI). **CAUTION** should be exercised with regard to the use of portable communications equipment in the area around such equipment.

SAFETY NOTES

VI. TO REDUCE THE RISK OF BURNS, ELECTRICITY, FIRE OR INJURY TO PERSONS

- Avoid using while bathing. If continuous usage is required by the doctor's prescription:
The concentrator must be located in another room at least 2.5m away from the bath.
- ⚠ **WARNING:DO NOT** come in contact with the concentrator while wet.
- ⚠ **WARNING:DO NOT** place or store product where it can drop into water or other liquid.
- ⚠ **WARNING:DO NOT** contact the product that has fallen into water. Unplug immediately.
- A product should never be left unattended when plugged in.
- This device is to be used only in accordance with the prescription of a doctor and this user's manual. If at any time the patient or attendant conclude that the patient is receiving an insufficient amount of oxygen, the supplier and/or doctor should be contacted immediately. No adjustments should be made to the flowrate unless prescribed by a doctor.
- Close supervision is necessary when this product is used near children or individuals with disability.
- Use this product for only intended use as described in this manual.
- ⚠ **WARNING:DO NOT** use parts, accessories or adapters other than those authorized by manufacturer.
- ⚠ **WARNING:DO NOT** connect the concentrator with other oxygen concentrators or oxygen therapy devices.
- Use of some administration accessories or certain humidifiers not specified for use with oxygen concentrator may impair the performance.

SAFETY NOTES

- In certain circumstances oxygen therapy can be hazardous. Manufacturer recommends that you seek medical advice before using this product.
- Avoid creation of any spark near medical oxygen equipment. This includes sparks from static electricity created by any type of friction.

FEATURES

I . SUMMARY

The function of oxygen

- Supplying oxygen to patients can assist in the treatment of heart head blood–vessel, respiratory system, such as chronic obstructive pneumonia disease, rehabilitation and hypoxia conditions.
- Oxygen could improve body function, especially suit for elderly, pregnant women, physique, students etc. who got physiological hypoxia. It may also reduce fatigue after heavy manual or mental consumption.

II . THE SCOPE OF PRODUCTS

For hospital and homecare to supply oxygen to patients.

III . STRUCTURE

- Complete plastic out shell, safe and reliable.
- Timing accumulates function, show total operating hours through the display screen.
- Compressor pressure relief valve help the device safer.
- Power interruption alarm function.
- Device failure alarm function (including pressure failure, compressor failure, low oxygen concentration).
- Compressor with over heat protect function to gain in safety of the compressor and the concentrator.
- * Nebulizer function. (8F–10W)

FEATURES

IV. SPECIFICATIONS

1. Maximum recommended flow: 10L/min.
2. Flow Range: 1L/min~10L/min.
3. Change in maximum recommended flow when back pressure of 7kPa is applied: $\pm 10\%$.
4. Oxygen Concentration: 95.5%~87%.
5. Maximum limited pressure :100kPa.(14.5psi)
6. Graph showing values of oxygen concentration as a function of flowrate at a nominal outlet pressure of zero (Figure 1):

Oxygen Concentration: %

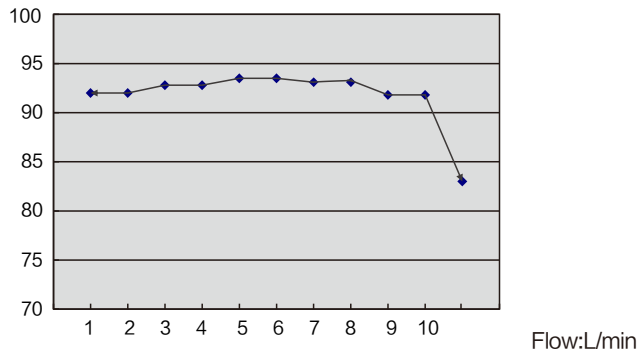

Figure 1

7. Trigger Pressure Of Pressure Relief Valve:
280kPa \pm 30kPa (40.61psi \pm 4.35psi)
8. Sound Level: ≤ 55 dB(A)
9. Maximum Nebulizing Rate: ≥ 0.15 mL/min(8F~10W).
10. Power Supply:
 AC100V $\pm 10\%$ AC110V $\pm 10\%$ AC120V $\pm 10\%$

FEATURES

- AC127V $\pm 10\%$ AC220V $\pm 10\%$ AC230V $\pm 10\%$
 - 50Hz 60Hz
11. Input Power: 700VA.
 12. Weight: 23.5kg.
 13. Dimension: W41cm (16.1") x D37.5cm (14.8") x H66.8cm (26.3").
 14. Altitude: Up to 1828 meters (6000 ft) above sea level without degradation of concentration levels. From 1828 meters (6000 ft) to 4000meters (13129 ft) below 90% efficiency.
 15. Safety system:
 - Over Current or Connection Loosen (Loss of Power): Alarming and Shut Down
 - Compressor Over Hot: Unit Shut Down
 - Pressure Failure: Alarming and Shut Down
 - Compressor Failure: Alarming and Shut Down
 - Low Oxygen Concentration Alarm
 - Low Flowrate Alarm
 16. Minimum operating time: 30minutes.
 17. Electric classification: Class II, type BF applied part.
 18. Work system: work continuously.
 19. Normal operation conditions:
 - Temperature range: 5°C~32°C (41 F~89.6°F);
 - Relative humidity: 15%~90%;
 - Atmosphere pressure: 860hPa~1060hPa (12.47psi ~ 15.37psi);

FEATURES

NOTE: When storage temperature is below 5°C , please keep the equipment in normal working condition for at least 4 hours before using.

20. Temperature at oxygen outlet: $\leq 46^{\circ}\text{C}$

21. Suggestion: The length of nasal oxygen cannula should be less than 15.2 meters and should not be pinched.

22. Transportation and storage conditions:

- Temperature range: $-20^{\circ}\text{C} \sim +60^{\circ}\text{C}$ ($-4^{\circ}\text{F} \sim +140^{\circ}\text{F}$),
- Relative humidity: 10%~93%, no condensation,
- Atmosphere pressure: 700hPa~1060hPa (10.15psi ~ 15.37psi).

NOTE: Oxygen concentrator should be stored with out intense sunlight, no corrosive gas and in a well ventilated room, avoid jolt and inverted recumbent transport.

HANDLING

I . UNPACKING

NOTE: Unless the oxygen concentrator is to be used immediately, otherwise it should be stored in the containers until it's being used again.

- › Check for any obvious damage to the carton or its contents. If damage is evident, please notify the carrier or local dealer.
- › Remove all loose packing from the carton.
- › Carefully remove all the components from the carton.

II . INSPECTION

- › Examine exterior of the oxygen concentrator for nicks, dents, scratches or other damages. Inspect all components.

III . STORAGE

- › Store the repackaged oxygen concentrator in a dry area.
- › DO NOT place other objects on top of the repackaged concentrator.

OPERATING & INSTALLATION

I . FEATURE VIEW

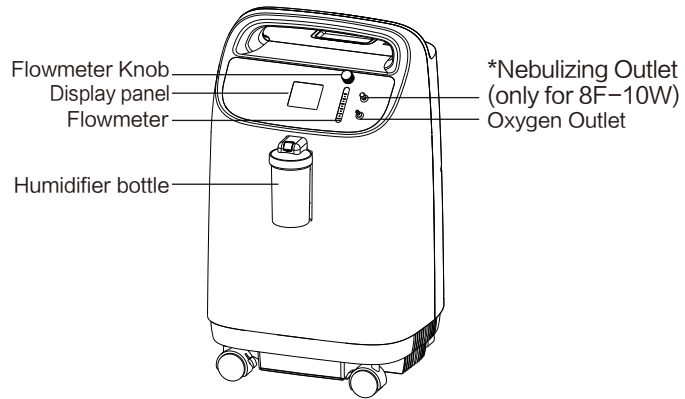

Figure 2: Front View

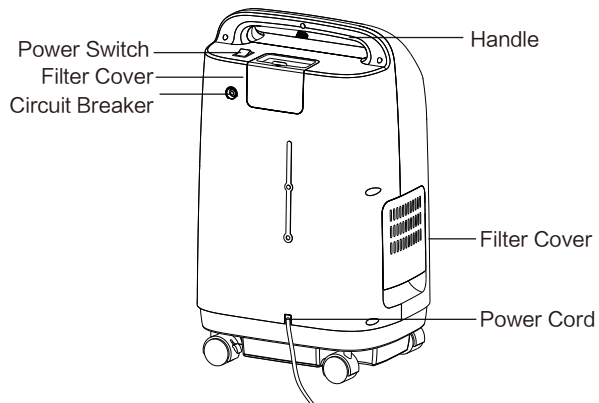

Figure 3: Rear View

OPERATING & INSTALLATION

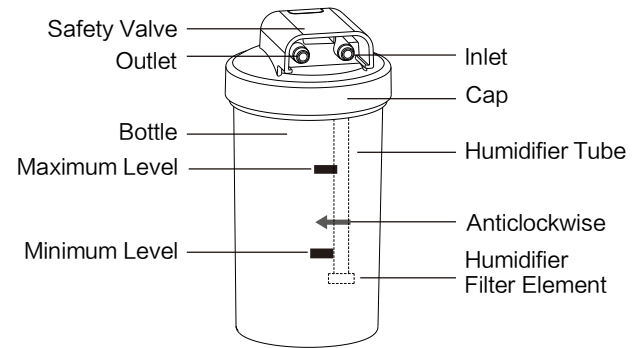
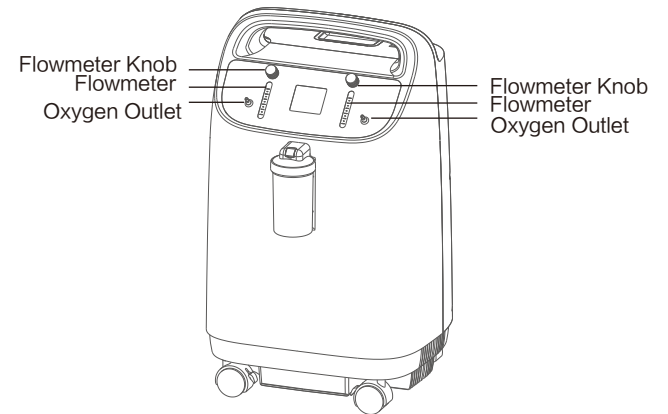

Figure 4: Humidifier Schematic Diagram



*Figure 5: Front View of 8F-10 Dual Flow

OPERATING & INSTALLATION

II. PREPARE WORK

- Take out the humidifier and remove the humidifier cap, then add pure water(or distilled water) until the water line is between the MAXIMUM Level and the MINIMUM Level (figure 4).

Note: The humidifier is located on the optimal installation location in the oxygen concentrator(Figure 2).

- Install the humidifier cap on the humidifier bottle, fasten it with the humidifier bottle, and place the humidifier in the installation slot of the oxygen concentrator.
- Plug in the power cord: Make sure the oxygen concentrator power switch is OFF, and then connect the power plug to a safety grounded outlet with power output.

⚠ CAUTION: DO NOT use extended power cord.

III. OXYGEN INHALING OPERATION

- When pressing the power switch to " | " position, "HELLO" will be shown on the display screen, and the blue, green and yellow indicators will be turned on at the same time, indicating that the machine is functioned properly. A few seconds later, total time will be shown on the display screen. When the oxygen concentrator is operated, it will send "Clicks" sounds every few seconds, which is the normal reversing and exhaust sound.

Adjust the flowmeter knob to the desired flow (the readings should be based on the black float center). Rotate the

- flowmeter knob upward to increase the flow and rotate it downward to reduce the flow (Figure 6). At the same time, there should be oxygen output at the humidifier oxygen outlet.

OPERATING & INSTALLATION

- Connect one end of the nasal oxygen cannula to the oxygen outlet of the humidifier, and place the other end (oxygen suction tip or nasal tip) on the patient, for the oxygen supply.

NOTE: For the oxygen inhalation time and the oxygen flow adjustment, please follow the doctor's advices.

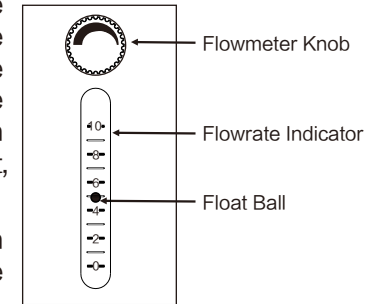
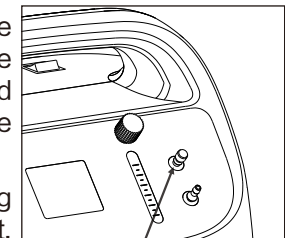

Figure 6: Setting Flowrate

⚠ CAUTION: If the flow rate shown on the flowmeter is less than 1L/min, check for tubings or attachments that are clogged, kinked, or wet flasks defective.

*IV. NEBULIZING OPERATION (only for 8F-10W)

- Fill proper medicinal liquid in the nebulizing cup (Please follow the doctor's advices or don't exceed the maximum reticle of the nebulizing cup).
- Upward pull out the nebulizing cover on the nebulizing outlet. (Figure 7)



Nebulizing Outlet plug

Figure 7

- Connect the air hose to nebulizing cup and nebulizing outlet, then turn on the power of the oxygen concentrator, nebulizing therapy begin immediately.
- NOTE: the time for nebulizing should follow the doctor's advices.

OPERATING & INSTALLATION

- When nebulizing finished, please turn the nebulizing cover right to nebulizing outlet for tightening. When the treatment finishes, please turn off the oxygen concentrator.
- Push the Nebulizing Outlet Plug in as deep as possible as the machine powered off.

V. ALARM SIGNALS



The machine has detection function as :

- (1)Pressure failure
- (2)Compressor failure
- (3)Over temperature
- (4)Low oxygen concentration
- (5)Low flowrate

Note:All the alarms of the device are low priority.

Initial startup of the concentrator

- After 5 minutes of the oxygen concentration start-up, the Oxygen sensor will work normally, and the indicator lights will be controlled according to the oxygen concentration value.
- Explanation of the indicator light

Symbol	Status	Indicator lights
OK	SYSTEM OKAY (O ₂ concentration is greater than 82%)	Green
	O ₂ concentration is less than 82%	Yellow
	Audio alarm paused	Blue

OPERATING & INSTALLATION

	System failure 1)Pressure failure alarm 2)Compressor failure alarm 3)Over temperature alarm 4)Power loss alarm 5)Low flowrate alarm	Yellow
---	--	--------

- The alarm signal

1. When the oxygen concentration is greater than 82% , the green indicator will be turned on, and the total time will be shown on the display screen, indicating normal operation.

2. When the oxygen concentration is less than 82% , the yellow indicators will be turned on, an alarm will be sent,at the same time and the total time will be shown on the display screen; please contact the supplier immediately. The user can continue to use the device, and please ensure that there is reserve oxygen nearby.

Note: After 30minutes from oxygen concentrator start-up, the oxygen concentration will be under the steady state.

3. In case of pressure or cycle failure alarm, the yellow indicator will be turned on, an alarm will be sent, "E1" or "E2" will be shown on the display screen, and the device shutdown. Please shut down the device immediately, use the reserve oxygen, and contact your supplier immediately.

4. In case of compressor failure alarm, the yellow indicator will be turned on, an alarm will be sent, "E3" or "E4" will be shown on the display screen, and the device must be shutdown. Please shut down the device immediately, use the reserve oxygen, and contact your supplier immediately.

OPERATING & INSTALLATION

5. In case of over temperature alarm, the yellow indicator will be turned on, an alarm will be sent, "E5" will be shown on the display screen, and the device must be shutdown. Please shut down the machine immediately, use the standby oxygen, and contact your supplier immediately.

6. In case of low flowrate alarm, the yellow indicator will be turned on, an alarm will be sent, "LL" will be shown on the display screen, and the device must be shutdown. Please shut down the machine immediately, use the standby oxygen, and contact your supplier immediately.















7. In case of power loss alarm, the yellow indicator will be turned on, an alarm will be sent, display off, and the device must be shutdown. Please check the power input.

VI. TURNNING OFF

- Take off nasal oxygen cannula from oxygen outlet first, turn off power switch, and then cut off power source.

OPERATING & INSTALLATION

VII. SYMBOLS

Symbol	Description	Symbol	Description
	Alternating current		Caution
	Class II Equipment		Type BF Applied part
	OFF(power)		ON(power)
	Fragile		Keep Up
	Stacking Limitation		Keep Dry
	Manufacturer		No Smoking
	Alarm status (Low priority)		Audio alarm paused
	No open flame:Fire,open ignition source and smoking prohibited		
IP21	Enclosures Protection classification The first characteristic number "2" : Protected against access to hazardous parts with a finger The second characteristic number "1" : Protected against vertically falling water drops.		

MAINTENANCE

⚠ WARNING: Before the maintenance of the oxygen concentrator, first cut off the power supply; in order to avoid electric shock, do not demantle the housing.

I . CLEAN THE HOUSING

Must clean the housing at least once a month: first, turn off the power supply and wipe it with a clean, soft, and damp cloth or sponge. Do not allow the liquid to enter the gaps in the housing.

II . CLEANING OR REPLACING FILTERS

Please clean and replace the filters in time, it's very important to protect compressor and extend device life.

⚠ WARNING: DO NOT operate the oxygen concentrator when the filter is not installed or wet; otherwise it may permanently damage the device.

Generally, clean or replace the Foam filter once per month. replace the Compressor intake filter per 1800 hours.

- › Removal: Foam filter is located on the side of the machine, it should be removed from the bottom on the filter cover directly. Compressor intake filter is located on the rear of the machine; it should be removed from the bottom of the filter cover directly. (Figure 8)

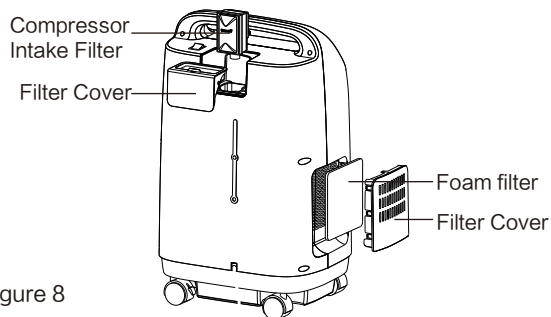

Figure 8

MAINTENANCE

● The actual cleaning time of filter should be determined on base of the actual use time and environmental impact.

● If the filter is dirty, it should be immediately cleaned or replaced regardless of the use time.(Compressor intake filter can only be replaced)

- › Cleaning: Clean the filter with mild cleaner and then rinse it with clean water, dry it and then install it on the machine.

III . CLEAN THE HUMIDIFIER

- › Must replace the water in the humidifier bottle once a day .
- › Must clean the humidifier bottle once a week at last with mild cleaner and then clean with water, to get the clean oxygen. When cleaning the humidifier, pay attention to clean the humidifier tube and the humidifier filter element in the low end of the humidifier to ensure the smooth flow of oxygen.

Remove the humidifier

- › (1)Turn the humidifier bottle counterclockwise. (Figure 9).
- › (2)Pull out the humidifier tube and the humidifier filter element.

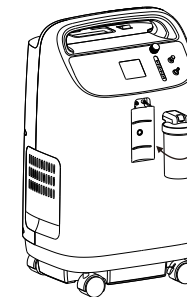

Figure 9

MAINTENANCE

* IV. CLEAN NEBULIZER (only for 8F-10W)

- › Clean the nebulizer components after using every time.
- › Pull out the air hose, pull the mouthpiece, downward pull the cap, empty remained medicinal liquid in the nebulizing cup, then wash the air hose, mouthpiece, cap, baffle, cup, ripple tube, T-piece, etc. , with pure water or immerge them in warm water for about 15 minutes (Figure 10). In order to wash them properly, you may add some vinegar in water.

NOTE: DO NOT cook the accessories above for wash or wash them with boiled water, in case they'll distort when heating.

- › After finishing washing you must dry all the accessories before storing.

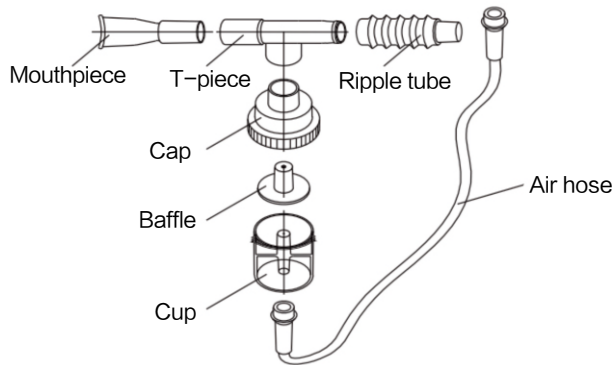

Figure 10: Nebulizer Components

TROUBLESHOOTING

Symptom	Probable cause	Solution
Power Interruption Alarm: Press the power on switch on the control panel, alarm, display not lit, device not work.	1) Power cord and wall outlet have poor contact.	1) Re-insert the power cord into wall outlet securely.
	2) Wall outlet no power output.	2) Change to another wall outlet.
	3) Low power of wall outlet.	3) Change to another wall outlet. Do not use any extension cord.
	4) Breaker reset button raised.	4) Press down the breaker reset button.
	5) If the device is still not working, please contact the supplier.	
Concentrator is working, the operating sound is normal, the flowmeter knob can be adjusted but no oxygen output or weak output.	1) Leakage between humidifier bottle and cap.	1) Re-install and tighten the humidifier cap
	2) The safety valve of humidifier is opened.	2) Shake the humidifier slightly to close the safety valve.
	3) The connection between oxygen output and humidifier is leaking.	3) Re-install the humidifier tubing.
	4) The accessory is leaking.	4) Replace the leaked accessory.
	5) If the phenomenon is still appeared, please contact the supplier.	
Concentrator is working, but yellow light illuminate alarm	1) Oxygen concentration <82%	1) Clean or replace the filter.
	2) Oxygen flow rate over the maximum recommend flow rate: 10L/min	2) Adjust the flow rate only under the advice of a physician.
	3) If the phenomenon is still appeared, the device can be used and please contact the supplier.	
Concentrator is not working, the yellow light illuminate, alarm, the display show "E1"	1) System cycle pressure is too low.	1) Clean or replace the filter .
	2) If the phenomenon is still appeared, stop using the device, please contact the supplier immediately.	

TROUBLESHOOTING

Symptom	Probable cause	Solution
Concentrator is not working, the yellow light illuminate, alarm, the display show "E2"	1)System cycle pressure is too high.	1)Stop using the device, please contact the supplier immediately.
Concentrator is not working, the yellow light illuminate, alarm, the display show "E3"	1)Compressor circuit is opened.	1)Stop using the device, please contact the supplier immediately.
Concentrator is not working, the yellow light illuminate, alarm, the display show "E4"	Compressor circuit is short.	Stop using the device, please contact the supplier immediately.
Concentrator is not working, the yellow light illuminate, alarm, the display show "E5"	System temperature is over.	Stop using the device, please contact the supplier immediately.
Concentrator is not working, the yellow light illuminate, alarm, the display show "LL"	1) oxygen flowrate is too low 2) If the phenomenon is still appeared, stop using the device, please contact the supplier immediately.	1) oxygen outlet or tubing accessories is blocked or kinked; or flowrate knob is turn down.

⚠ CAUTION: If you have any other problems, TURN OFF the concentrator first, use your reserve oxygen supply, and contact the supplier immediately.

TROUBLESHOOTING

Symptom	Probable cause	Solution
*During nebulizing operating, the amount of nebulization is small or cannot be nebulized. (Only for 8F-10W)	1) Nebulizer components are not installed in place or incorrect.	1) Install nebulizer components correctly.
	2) Nebulizer components are deformed after cleaning or disinfection.	2) Replace nebulizer components.
	3) Nozzle of nebulizer components is blocked.	3) Clean or replace nebulizer components.
	4) Excessive liquid added	4) Add an appropriate amount of liquid into the nebulizer cup, which shall not exceed the maximum level.
	5) If the phenomenon is still appeared, stop using the nebulization components, please contact the supplier immediately.	
The nasal cannula is fogged with vapor or full of liquid drops. (Remove the vapor or liquid drops method: Turn on the device and connect the tubing to the oxygen outlet. Use your finger to block and release the end of the tubing several times to remove the moisture and liquid.)	1) Poor ventilation around the around the device, so operating temperature is too high.	1) Make sure the device is at least 10 cm away from the walls, other jam or heater.
	2) The water which added to humidifier is too hot.	2) Add cold water to humidifier.
	3) Add too many water into humidifier.	3) Water added should between the maximum and minimum levels in humidifier.
	4) The device stops suddenly during operating.	4) Turn off the device immediately. Restart the device to remove the moisture and liquid.
	5) Accessory is connected to the device. The tubing is kinked and the device stops suddenly.	5) Smooth the nasal cannula and tubing.
	6) Cooling fan which mounted inside the device stop running or rotate slowly, make the operating temperature is too hot.	6) Replace the cooling fan. Note: Cut off the power first. And perform by qualified personnel only.
	7) If the phenomenon is still appeared, the device can be used and please contact the supplier.	

OTHER ATTENTION ITEMS

I. GAS PASS OPERATION SKETCH MAP:

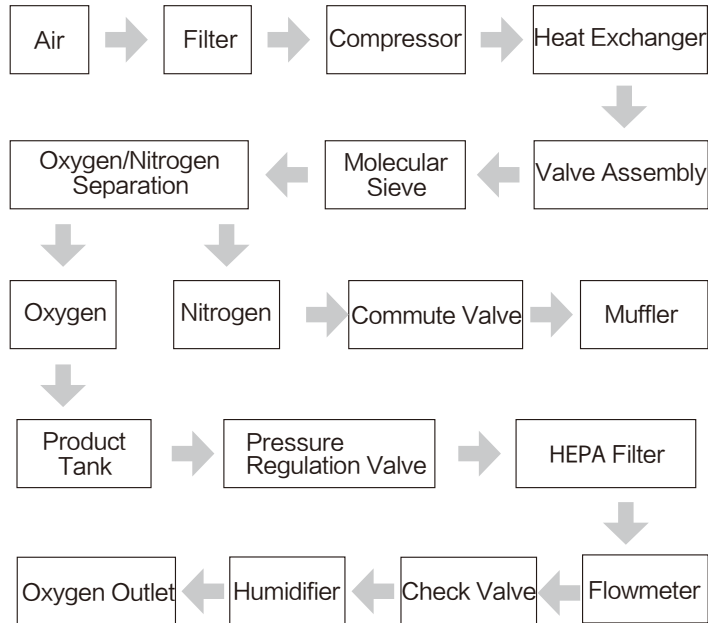

OTHER ATTENTION ITEMS

II. ELECTRICAL RATIONALE

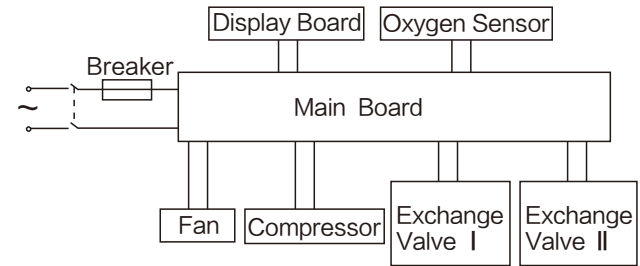

III. ACCESSORIES LIST

1.Nasal cannula	1set
2.User's manual	1piece
3.Foam filter	1set
*4.Nebulizer(only for 8F-10W)	1set

IV. DEVICE DISPOSAL

Contact the local city or town offices for proper disposal instructions for oxygen concentrator.